



Development and validation of the ‘Lebender emoticon PANAVA’ scale (LE-PANAVA) for digitally measuring positive and negative activation, and valence via emoticons

Marc Schreiber^{a,*}, Gregor J. Jenny^b

^a IAP Institute of Applied Psychology, School of Applied Psychology, Zurich University of Applied Sciences (ZHAW), Pfingstweidstrasse 96, 8005 Zürich, Switzerland

^b Center of Salutogenesis, Division of Public and Organizational Health, Epidemiology, Biostatistics and Prevention Institute, University of Zurich, Switzerland

ARTICLE INFO

Keywords:

Positive activation
Negative activation
Valence
PANAVA
Emoticon
Experience sampling method (ESM)

ABSTRACT

Positive and negative activation (PA/NA) represent two general activation systems of affect that are of importance for studying personality. Hereby, many studies focus on state assessment of PA and NA in everyday situations, using the ‘Experience Sampling Method’ (ESM) performed via mobile devices. ESM studies require short, reliable and validated non-verbal scales for immediate and fast capturing of personality and situation characteristics. In this study we present the non-verbal ‘Lebender Emoticon PANAVA’ scale (LE-PANAVA), consisting of five items capturing PA, NA, and valence (VA). LE-PANAVA is based on the 10-item verbal PANAVA-KS scale developed by Schallberger (2005). The development of LE-PANAVA consisted of a three step process: The graphical development and selection of a set of emoticons (study 1), the validation of the set of emoticons and corresponding adjustments to the scale (study 2), and validation of the final scale (study 3). We conclude from the results that LE-PANAVA captures the two factors PA and NA, but are aware that they are closely interrelated. Additional to LE-PANAVA, an ultra-short version was derived, that is, a forced choice 2×2 matrix of emoticons – the ‘Lebender Emoticon PANA Matrix’ (LE-PANA-M). Both LE-PANAVA and LE-PANA-M are available for future research and practical application.

1. Introduction

Positive and negative activation (PA/NA) are considered as two general activation systems of affect (Tellegen, Watson, & Clark, 1999; Watson, Wiese, Vaidya, & Tellegen, 1999) and have been studied in many fields of research. For example, the role of PA and NA has been examined in relation to subjective well-being and flow (Diener, Suh, Lucas, & Smith, 1999; Jayawickreme, Forgeard, & Seligman, 2012; Schallberger & Pfister, 2001), job satisfaction (Schallberger, 2006), and personality traits (Hengartner, Graf, & Schreiber, 2017; Heubeck & Wilkinson, 2019). Within personality psychology, PA and NA have also become relevant as part of functional (Kuhl, 2018) and dynamic approaches of personality (Little & Coulombe, 2015). Further studies demonstrated substantial correlations between personality traits and momentary affective activation (Howell, Ksendzova, Nestingen, Yerahian, & Iyer, 2017; Komulainen et al., 2014; Wilt & Revelle, 2019), especially between Extraversion and PA (Wilt, Nofle, Fleeson, & Spain, 2012).

PA and NA are usually measured using adjective-based scales such

as the ‘Positive and Negative Affect Schedule’ (PANAS; Watson, Clark, & Tellegen, 1988) or the ‘Scale of Positive and Negative Experience’ (SPANE; Diener et al., 2009, 2010). Further, researchers are making full use of the pervasiveness of smartphones and tablets for capturing PA and NA in a timely and contextualized manner through the ‘Experience Sampling Method’ (ESM; Conner, Tennen, Fleeson, & Barrett, 2009; Csikszentmihalyi & Larson, 2014), also referred to as ecological momentary or ambulatory assessment (Ebner-Priemer & Trull, 2009; Wright & Zimmermann, 2019). According to Conner et al. (2009, p. 293) these methods can be characterised by three qualities: ‘(...) they assess data in natural settings, in real-time (or close to real time occurrence), and on repeated time occasions’. Furthermore, ESM focuses on both within- and between-subject analyses of people’s self-reported feeling and thinking, and/or people’s physical movement, social interactions, or daily activities through ‘Smartphone Sensing Methods’ (SSMs; Harari, Müller, Aung, & Rentfrow, 2017), such as Global Positioning System (GPS) scans, accelerometer, microphone, or light sensor recordings. For this kind of research, short, verbal as well as non-verbal scales are needed. Schallberger (2005) developed the PANAVA-KS for

* Corresponding author.

E-mail address: marc.schreiber@zhaw.ch (M. Schreiber).

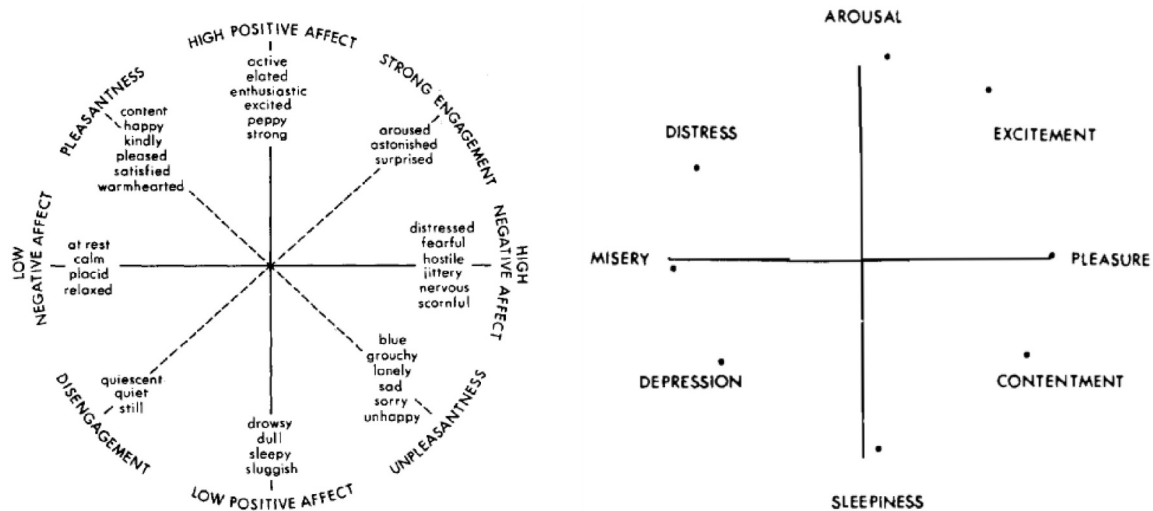

Fig. 1. Watson & Tellegen's (1985, p. 221; left side) two general activation systems of affect and Russell's (1980, p. 1164; right side) 'Circumplex Model of Affect'.

ESM research, a 10-item scale with bipolar adjectives assessing PA and NA, as well as valence (VA) capturing pleasure (see Russell, 1980) as an additional dimension. In this study, we present LE-PANAVA as well as LE-PANA-M, two emoticon-based versions of the PANAVA-KS that can be used non-verbally in ESM studies.

2. Background

The terms positive and negative activation (PA/NA) have been introduced by Tellegen et al. (1999; Watson et al., 1999). Originally, Watson and Tellegen (1985) proposed a model of two general activation systems of affect with positive (e.g. active, enthusiastic) and negative affect (e.g. distressed, nervous) as two unipolar dimensions (see Fig. 1, left side). In doing so, they referred to the 'Circumplex Model of Affect' developed by Russell (1980; see also Posner, Russell, & Peterson, 2005; Russell & Carroll, 1999; see Fig. 1, right side), who distinguished between two orthogonal dimensions, namely 'pleasure' (also called pleasantness, valence) and 'arousal' (also called engagement, activation). Positive and negative affect can be seen as a 45° rotation of pleasure and arousal (Watson et al., 1999).

In order to foster terminological clarity and referring to Gray's (1982) two basic biobehavioral systems of activation, as well as to Thayer's (1989) concept of 'Energetic Arousal' (EA; energetic activation) and 'Tense Arousal' (TA; tension activation), Tellegen et al. (1999, p. 298; see also Watson et al., 1999, p. 827) renamed positive and negative affect into *positive and negative activation (PA/NA)*. They also pointed to state PA as motivating source of approach behavior and to state NA as having an effect on avoidance and vigilant behavior. In both state ('How do you feel at the moment?') and trait instructions ('How do you feel in general?'), PA and NA are designed to capture within- and between-subject differences. According to Watson et al. (1999; see also Schallberger, 2005, p. 13), PA and NA represent the following unipolar states of activation (see Fig. 1, left side): High PA comprises positively valued states with a high degree of activation (e.g. enthusiastic); at the low end are negatively valued states characterized by low PA (e.g. dull). Analogously, high NA comprises negatively valued states with a high degree of activation (e.g. distressed); at the low end are positively valued states characterized by low NA (e.g. relaxed). Watson et al. (1999; see also Howell et al., 2017; Komulainen et al., 2014; Wilt & Revelle, 2019; Wilt et al., 2012) reported substantial correlations of PA and NA with the 'Big Two' personality traits of Extraversion (with PA) and Neuroticism (with NA).

2.1. Measures of positive and negative activation (PA/NA)

The 'Positive and Negative Affect Schedule' (PANAS; Watson et al., 1988) is the most widely used measure for PA and NA (Brose, Schmiedek, Gerstorff, & Voelkle, 2019). The two dimensions PA and NA, named 'affect' after the initial understanding of the above described two general activation systems of affect (see Fig. 1, left side), are usually measured by 20 items (see methods section). Recent work examined the relation of PA and NA regarding the PANAS: Seib-Pfeifer, Pugnaghi, Beauducel, and Leue (2017; see also Crawford & Henry, 2004; Thompson, 2007) investigated the factor structure of PANAS trait ratings by means of confirmatory factor analyses (CFA). Thereby they also tested Gaudreau, Sanchez and Blondin's (2006) three-factor model, which divides NA into two factors called 'NA-upset' and 'NA-afraid', as well as a bifactor model which best fitted to their data. They discussed the implications of bifactor models in the context of affect research and took their findings as a confirmation of the structural ambiguity due to underlying circumplex structures often found in combination with the PANAS. Heubeck and Wilkinson (2019) compared different models for state and trait measures of the PANAS and didn't find any support for the existence of a bifactor model that can be explained in a meaningful way. Diener et al. (2009, 2010; see also Busseri, 2018) developed the 'Scale of Positive and Negative Experience' (SPANES), covering a broader range of feelings and emotions (e.g. positive, negative, afraid, joyful) they considered being important to well-being.

Schallberger (2005) pointed to various characteristics of the PANAS that are unfavorable, especially for ESM studies, for which he developed the 10 item PANAVA-KS (see Fig. 2; 'KS' stands for the German abbreviation of Kurz-Skala, i.e. 'short-form'). He focused on optimizing participant's compliance as well as data structure complexity due to within- and between-subject analyses in ESM studies. According to him, unipolar rating scale items such as the ones used for PANAS and SPANES are prone to acquiescence and therefore tend to produce skewed item distributions with reduced variance. Thus, PANAVA-KS uses bipolar items, which leads to more item variance as well as to better control of the response style (Schallberger, 2005, p. 21/22; see also Tourangeau, Couper, & Conrad, 2007; Van Vaerenbergh & Thomas, 2013).

PANAVA-KS assesses Watson and Tellegen's (1985) two general activation systems of affect (PA/NA; see Fig. 1, left side). Schallberger (2005) added the classical valence dimension (VA; Russell, 1980) to the PANAVA-KS because of VA's importance as a dependent variable in ESM studies and in order to be able to further

How do you feel at the moment? (Put a cross in each row at the point which best corresponds with your feelings)								
	(3)	(2)	(1)	(0)	(1)	(2)	(3)	
	very		undecided				very	
satisfied	<input type="radio"/>	<input type="radio"/>	<input type="radio"/>	<input type="radio"/>	<input type="radio"/>	<input type="radio"/>	<input type="radio"/>	dissatisfied
full of energy	<input type="radio"/>	<input type="radio"/>	<input type="radio"/>	<input type="radio"/>	<input type="radio"/>	<input type="radio"/>	<input type="radio"/>	no energy
stressed	<input type="radio"/>	<input type="radio"/>	<input type="radio"/>	<input type="radio"/>	<input type="radio"/>	<input type="radio"/>	<input type="radio"/>	relaxed
tired	<input type="radio"/>	<input type="radio"/>	<input type="radio"/>	<input type="radio"/>	<input type="radio"/>	<input type="radio"/>	<input type="radio"/>	wide awake
peaceful	<input type="radio"/>	<input type="radio"/>	<input type="radio"/>	<input type="radio"/>	<input type="radio"/>	<input type="radio"/>	<input type="radio"/>	angry
unhappy	<input type="radio"/>	<input type="radio"/>	<input type="radio"/>	<input type="radio"/>	<input type="radio"/>	<input type="radio"/>	<input type="radio"/>	happy
listless	<input type="radio"/>	<input type="radio"/>	<input type="radio"/>	<input type="radio"/>	<input type="radio"/>	<input type="radio"/>	<input type="radio"/>	highly motivated
calm	<input type="radio"/>	<input type="radio"/>	<input type="radio"/>	<input type="radio"/>	<input type="radio"/>	<input type="radio"/>	<input type="radio"/>	nervous
enthusiastic	<input type="radio"/>	<input type="radio"/>	<input type="radio"/>	<input type="radio"/>	<input type="radio"/>	<input type="radio"/>	<input type="radio"/>	bored
worried	<input type="radio"/>	<input type="radio"/>	<input type="radio"/>	<input type="radio"/>	<input type="radio"/>	<input type="radio"/>	<input type="radio"/>	free of worry

Fig. 2. PANAVA-KS (state instruction), translated to English (German items see Fig. 4).

analyze the factor structure of the general activation systems of affect. He found evidence for a two-factor structure (PA and NA) and documented PANAVA-KS' (only PA and NA) convergent validity with PANAS.

Schallberger and Pfister (2001; see also Schallberger, 2006) applied the PANAVA-KS – amongst others – in an ESM study on daily experiences in the working context. Other researchers have adopted the PANAVA-KS in domains such as school (Zurbriggen, Venetz, & Hinni, 2018), organizational health interventions (Lehmann, Brauchli, Jenny, Füllemann, & Bauer, 2018), or personality dynamics (Hengartner et al., 2017).

2.2. Digital mobile studies in applied research

Since its beginnings, applied psychology has dealt with new technologies and investigated their use in everyday life (see e.g. Münsterberg, 1916). Digitization brought a wide range of new technologies that can be used for research, such as the pagers widely used in the 1990s for the above-mentioned ESM studies. Depending on the study goals, questions referred to current activities, situation characteristics, or the perception of cognitive, emotional or motivational states. At that time, self-assessments were carried out with small paper-and-pencil self-report forms (Larson & Csikszentmihalyi, 2014). Presently, mobile devices such as smartphones, -watches, or tablets are the tools of choice for these research purposes (e.g. Jones, Brown, Serfass, & Sherman, 2017; Runyan et al., 2013). The use of digital-mobile methods is very common in intervention studies, especially in the therapeutic-clinical field (Andersson, 2018; Boonstra et al., 2018; Jacobi, 2019) and in the broader field of health-oriented behavior, labeled as e-, m-, u- or v-Health (electronic, mobile, ubiquitous, virtual), and also including serious gaming and gamification approaches (see e.g. Lehr et al., 2016).

2.3. Existing non-verbal measures for affective activation

In many of the studies in applied research, non-verbal scales referring to the above-mentioned 'Circumplex Modell of Affect' (Russell, 1980) are used. For example, Gloor, Colladon, Fronzetti, Grippa, Budner, & Eirich, (2018) developed single-item emoticons to assess valence and activation with smartwatches (Budner, Eirich, & Gloor, 2017). Pollak, Adams, and Gay (2011) developed the 'Photographic Affect Meter' (PAM) to assess arousal and valence for frequent,

in situ measurement of affect. It consists of a wide variety of photos, where participants select one photo that best suits their current mood. Finally, the 'Affective Slider' (AS; Betella & Verschure, 2016) consists of two sliders measuring pleasure and arousal. Alike the 'Self-Assessment Manikin' (SAM; Bradley & Lang, 1994), a non-verbal pictorial assessment technique that covers pleasure, arousal, and dominance related to an object or an event, the AS applies emoticons, but only at both ends of the two sliders. Betella and Verschure (2016) state that the still widely used SAM (Bradley & Lang, 1994) not only needs too much verbal instruction, but is also outdated. Therefore, they developed the AS and referring to the SAM found a very high convergent validity. This very manageable number of existing and properly validated non-verbal scales is confronted with an increasing demand for such scales in diverse fields of application. This is all the more surprising since non-verbal communication elements such as emoticons have become widely accepted in everyday life.

2.4. Advantages of non-verbal measures for affective activation

In the following, we want to highlight the advantages of non-verbal scales over verbal scales: First, non-verbal, image-based scales address the respondents via the visual channel, thus enabling a different approach that is also independent of language and reading skills. Second, they are intuitive and allow for fast and direct measures of situation and personality characteristics. Third, visual scales minimize the time it takes respondents to answer, increasing acceptance and reducing dropout rates of studies. Fourth, the playful character of visual measurement instruments can increase the commitment of study participants. As a consequence, non-verbal scales are ideally suited for digital-mobile measurement in everyday situations such as ESM. To our knowledge, until today there is no non-verbal scale that captures PA and NA according to Tellegen et al. (1999; see also Watson et al., 1999), as outlined above. Based on the PANAVA-KS (Schallberger, 2005), we present the 'Lebender Emoticon PANAVA' scale (short: LE-PANAVA), named after the fine arts student who designed the emoticons (see acknowledgements). LE-PANAVA was designed as a non-verbal scale for digital-mobile ESM studies that includes state measures of positive and negative activation (PA/NA). As it is based on the PANAVA-KS, it also includes valence (VA) as a measure of pleasure. We furthermore present a forced-choice matrix version, the 'Lebender Emoticon PANA Matrix' (short: LE-PANA-M). LE-PANA-M consequently follows Schallberger's

(2005) claim for very short and preferably non time-consuming state measures for use in ESM studies. For the development of the scales, three studies were conducted. Following, we present the aims, methods, and results for each study, as well as an overall discussion.

3. Study 1: Graphical development and selection of a set of emoticons

3.1. Aim

In study 1, we aimed to graphically develop a set of emoticons that represents the two activation systems of affect described by the verbal items of the PANAVA-KS scale.

3.2. Methods

The graphical development of the items was done by students of a university of arts (see acknowledgements). The existing PANAVA-KS scale (Schallberger, 2005) formed the basis for item development (see Fig. 2 for item wording). The 10 pairs of adjectives were sent to four students to sketch a monochrome set of emoticons for each adjective (e.g. highly motivated or angry) and present their solutions to the researchers and discuss them in class. Thereafter, three sets were chosen for empirical analysis, although only one student sketched emoticons for all 10 pairs of adjectives. Each emoticon was presented in an online survey through snowball sampling ($n = 152$) in German speaking countries (Switzerland, Germany, Austria), presenting the emoticons to the respondents who had to choose which of two adjectives (a distractor vs. the correct label) represented its character. To collect quick and intuitive responses, no demographic information or further data was collected. Each emoticon was rated 20 times. Based on the average percentage of correct classifications and the potential for further development and refinement, a set was chosen and optimized by the student.

3.3. Results

Over all sets, the emoticons were classified in average correctly in 75% of the ratings. As the sets varied in their number of emoticons, we selected the best rated emoticon for each of the four categories (i.e., PA and NA, high and low), which revealed that all sets achieved 79–87% correct classifications in average. Best ratings in all sets were for the emoticon depicting ‘anger’ (90–98% correctly classified).

Based on these results, all sets could have been chosen for further development and refinement. Therefore, we selected the set of the student who had already sketched all 10 pairs of emoticons (Fig. 3, middle emoticon) and assigned her to refine those emoticons with lower ratings (final set depicted in Fig. 4). The final emoticons presented in Fig. 4 can be downloaded as JPG-files from the OSF repository (see <https://osf.io/tm7cx/>). Fig. 4 shows that high NA emoticons and

low PA emoticons are very distinguishable. High PA emoticons proved to be the most difficult to sketch, as they turned out to be very similar and close to high VA. Further, some low NA emoticons tend to come close to the high PA and VA emoticons.

4. Study 2: Validation of the set of emoticons and corresponding adjustments to form short measures for digital-mobile measurement

4.1. Aim

In study 2, we aimed to show that the emoticons capture two distinct states of the general activation systems of affect, as measured with the German PANAVA-KS scale. Subsequently we aimed to form short measures ideally suited for digital-mobile measurement such as ESM.

4.2. Methods

The selected set of emoticons was applied in an online survey, together with PANAVA-KS for construct validation. The emoticons were listed analogous to the PANAVA-KS scale, that is, in the same sequence and with varying directions of rating (see Fig. 2) but assessed with a 0–100% slider between them and presented five pairs at a time on one page of the online questionnaire. For further construct and criterion validation, we utilized the following scales (all in German): PANAS (Krohne, Egloff, Kohlmann, & Tausch, 1996); 20 adjectives indicating how one is feeling at the moment (state), ranging from 1 = ‘not at all’ to 5 = ‘extremely’, e.g. active), and the subscales ‘Extraversion’ and ‘Neuroticism’ (see background section) of the MRS personality inventory (Schallberger & Venetz, 1999); 8 pairs of adjectives rated on a bipolar scale with 6 increments, e.g. talkative – silent). Cronbach alphas were satisfactory for all scales (see Table 2). Data was collected through a German online panel operator, yielding a sample of 220 respondents. The use of online panel services for research is subject of ongoing discussions: A recent meta-analysis found comparable patterns between variables in online panel samples and traditional samples (Walter, Seibert, Goering, & O’Boyle, 2018), and the authors suggest that with appropriate caution online panels are suitable for exploratory research and to test hypotheses about the general population. The average amount of time to complete the measures was 8.2 minutes ($SD = 5.8$). Speeders (i.e., response time equal or below 120 s) and straightliners (i.e., response patterns in one vertical line in the emoticons or PANAVA-KS) were excluded from the sample ($n = 4$). Multivariate outliers in the PA/NA items of the emoticons or PANAVA-KS were also excluded based on Mahalanobis Distance (cut-of criteria of 26.124 for $df = 8$ and $p < .001$; $n = 12$). There were no missing values, as respondents had to choose an answer to continue with the survey. Overall, 16 cases were excluded. The final sample consisted of 204 German-speaking respondents, whereof 46.1% were female, mean age was 45.2 ($SD = 14.6$), and 33.8% had a higher education degree. First,

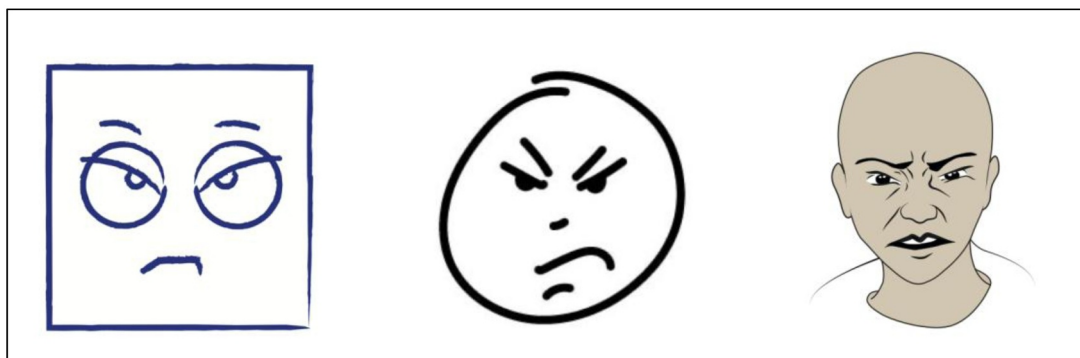

Fig. 3. Example emoticon ‘angry’ for each sketched set (by Gioia Loretz, Maren Lebender, Rahel Kern).

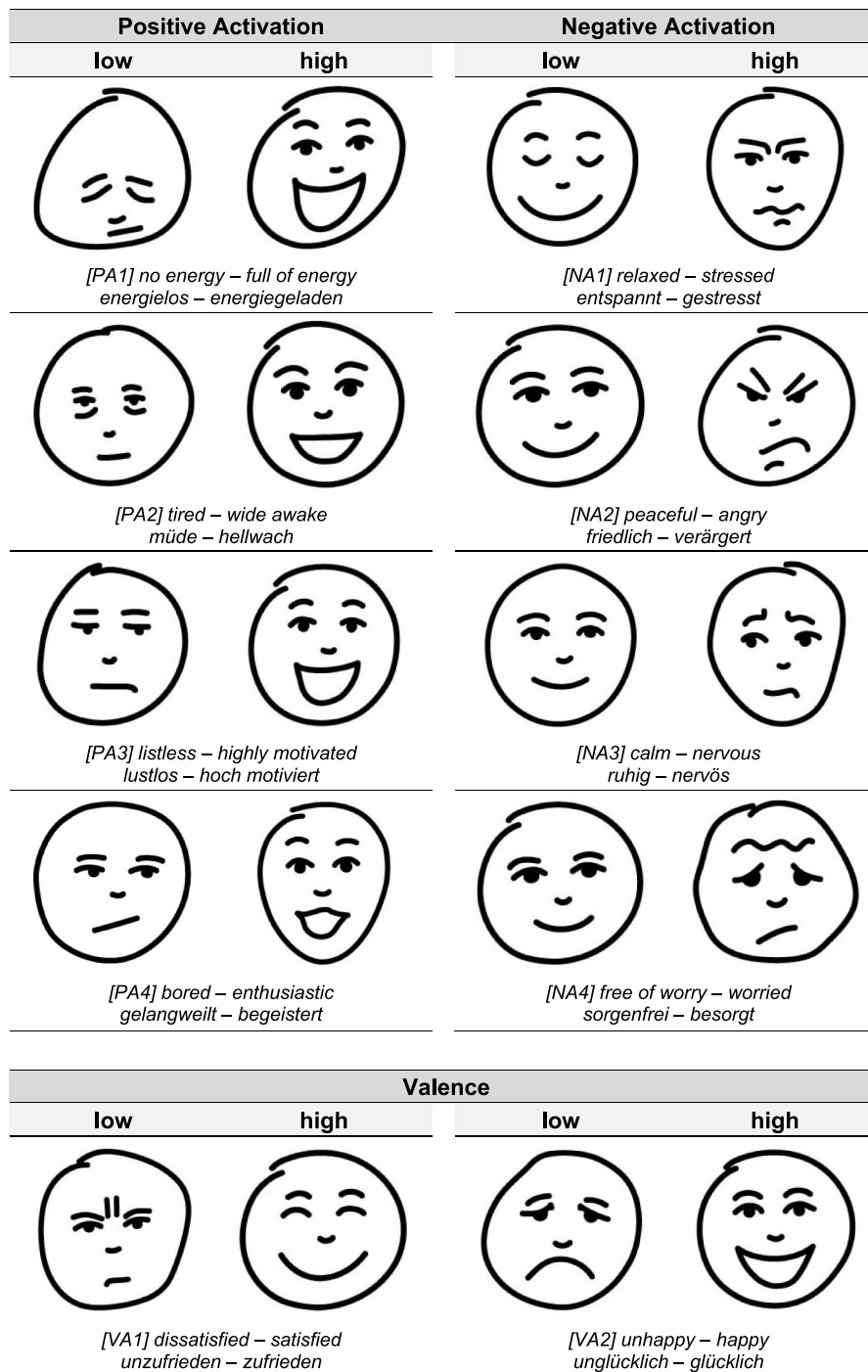

Fig. 4. Complete set of the emoticons developed for the LE-PANAVA scale (all emoticons are available as JPG-files in the OSF repository).

we conducted confirmatory factor analyses (CFAs) of the emoticons, comparing a series of two-factor solutions as well as a bifactor model (analysis was done with PA and NA only; see background section). CFAs were computed with the lavaan R package (Rosseel, 2012). Sample size ($n = 204$) was sufficient according to Bentler and Chou (1987). As multivariate normal distribution was not given, we performed robust maximum likelihood estimation using the Satorra-Bentler scaled correction (χ^2_{SB} ; Satorra & Bentler, 1994) to assess the model fit. We further adopted the corrected comparative fit index (CFI), the corrected Tucker-Lewis index (TLI), and the root mean square error of approximation (RMSEA). A model is considered to have an acceptable fit if the CFI, and TLI values are about 0.95 or above; and if the RMSEA value is

equal or below 0.06 (Hu & Bentler, 1999; Shevlin & Miles, 1998). Second, we examined the emoticons' histograms and the correlations with the PANAVA-KS scales (PA/NA) as well as the criterion scales. Third, we split the verbalized PA and NA scales (PANAVA-KS) into three groups (low, medium, and high activation; based on the scale's verbalization where the three middle rows of response capture a medium or indifferent state, respectively; see Fig. 2), to compare states of verbally expressed activation with the mean values of the emoticons. Based on these results, adjustments were made to the assessment of the emoticons to form a reduced set of emoticons (LE-PANAVA) as well as the forced-choice matrix version (LE-PANA-M). Analysis were conducted with SPSS 25 and R (R Core Development Team, 2019).

Table 1
CFA for emoticons.

	χ^2_{SB} (df)	CFI	TLI	RMSEA	LO 90	HI 90	$\Delta\chi^2_{SB}$	Δdf
M1: Two PA-NA factors, orthogonal	314.5 (20)	.781	.694	.269	.247	.291	–	–
M2: Two PA-NA factors, correlated	29.3 (19)	.992	.989	.052	.016	.080	285.2***	1
M3: M2 + errors (NA1/NA2; NA3/NA4)	19.7 (17)	.998	.997	.028	.000	.065	9.6**	2
M4: M2 + bifactor	14.1 (12)	.998	.996	.029	.000	.072	15.2**	7

Note: χ^2_{SB} = Satorra-Bentler corrected χ^2 ; CFI = comparative fit index; TLI = Tucker–Lewis index; RMSEA = root mean square error of approximation; ** $p < .01$; *** $p < .001$.

4.3. Results

CFA of the emoticons showed that the two factor model with PA and NA as orthogonal factors (M1) reached a poor fit, $\chi^2_{SB}(20) = 314.5$, CFI = 0.781, TLI = 0.694, RMSEA = 0.269, whereas the two factor model with PA and NA as correlated factors (M2) fitted the data reasonably well, $\chi^2_{SB}(19) = 29.3$, CFI = 0.992, TLI = 0.989, RMSEA = 0.052 (see Table 1). Based on the modification indices, the errors of the NA items ‘angry’ and ‘stressed’ as well as ‘nervous’ and ‘worried’ were allowed to correlate (M3), further improving the fit of the two-factor solution, $\chi^2_{SB}(17) = 19.7$, CFI = 0.998, TLI = 0.997, RMSEA = 0.028. These error correlations are meaningful from two perspectives: on the one hand, the respective pairs of emoticons were presented together on one page of the online questionnaire, and on the other hand they capture two states of negative activation that – according to Gaudreau, Sanchez, and Blondin (2006) – could be described as ‘NA-upset’ and ‘NA-afraid’ (see background section). M3 showed the strongest and most parsimonious fit to the data (see Table 1). The bifactor model (M4) alike reached very good fitting indices, $\chi^2_{SB}(12) = 14.1$, CFI = 0.998, TLI = 0.996, RMSEA = 0.029, that are almost identical to those of M3. Thus, we conclude that the emoticons capture two states of activation – PA and NA – and reveal patterns of correlation congruent with the literature.

Histograms of the emoticon scales revealed low skewness for PA (-0.392) and moderate skewness for NA (0.620) (for a rule of thumb see Bulmer, 1979), whereby 4.9% of the cases had maximum ratings for high PA and low NA, respectively. In the single items, percentages of maximum ratings ranged from 6.4% to 10.3%. Overall, the panel respondents seemed to be mainly low in NA and medium in PA (see mean values in Table 2). Correlations between the two emoticon scales were very high ($r = -0.93$) and showed no differentiality between the PANAVA-KS scales. Thus, the correlation patterns of the emoticons with the criterion variables resembled those of the PANAVA-KS and PANAS scales.

All emoticon items showed equal patterns of mean values in the three PA and NA verbal groups, respectively (Fig. 5). There seems to be a bias when responding to the emoticons: PA emoticons tend to get higher ratings than expected from the non-verbal rating, whereas NA emoticons get lower ratings than expected. In other words: Medium ratings on the verbalized PA scale should result in PA emoticon mean values around 50 – in our sample, they ranged between 61 and 66.

Table 2

Means (M), standard deviations (SD), internal consistencies (Cronbach's α) and correlations between the study variables of study 2 ($N = 204$).

Variables	M	SD	α	1	2	3	4	5	6	7	8
1. PA emoticon	64.86	21.71	.95	1.00							
2. NA emoticon	30.96	20.92	.96	-0.93	1.00						
3. PA PANAVA-KS	4.33	1.27	.85	0.74	-0.72	1.00					
4. NA PANAVA-KS	3.41	1.24	.80	-0.67	0.66	-0.72	1.00				
5. PA PANAS	3.09	.76	.91	0.65	-0.60	0.80	-0.54	1.00			
6. NA PANAS	1.86	.72	.77	-0.61	0.62	-0.61	0.71	-0.41	1.00		
7. MRS Extraversion	3.71	.92	.72	0.38	-0.34	0.42	-0.34	0.49	-0.28	1.00	
8. MRS Neuroticism	3.92	.97	.78	0.56	-0.56	0.72	-0.65	0.67	-0.54	0.39	1.00

Note. All correlations are statistically significant ($p \leq .01$ or $p \leq .001$)

Similarly, NA emoticon mean values of medium ratings on the verbalized NA scale ranged between 32 and 36.

Based on these analyses we concluded that PA and NA emoticons can be differentiated as two distinct activation factors as measured by PANAVA-KS, but their presentation and rating have to be carefully considered. The high amount of maximum values suggests that respondents move the sliders too readily to the ends. This is further exacerbated by presenting too many emoticons at a time and on one page of the online questionnaire. Therefore, we decided to adjust both the amount and presentation of the emoticons, presenting fewer and one at a time, with a scale instead of a slider, situated below the emoticons to form the final 5-item LE-PANAVA scale (Fig. 9). Further, the mean values of the emoticons in Fig. 5 suggested that each one of them was suitable for selection. Thus, we aimed for optimal variation in emoticon expressions and selected PA3, PA4, NA2, NA3, and VA2 for further analysis. The two expressive emoticons depicting PA1 low (no energy) and PA2 low (tired) were hereby not considered, as analysis of PANAVA-KS data often reveals that they also capture a state of exhaustion that covaries strongly with high NA. To achieve higher discriminability, we replaced PA3 high (highly motivated) with PA1 high (full of energy) and NA2 low (peaceful) with NA1 low (relaxed) (see Figs. 4 and 9). Although this selection process of emoticons is based on the fact that each pair of emoticons covaries with the PANAVA-KS scale in a similar way and thus would be eligible for further application (Fig. 5), the selection of the LE-PANAVA items is based on the authors subjective perception of optimal variation of the emoticons. Other researchers may select other pairs of emoticons for their specific applications (all emoticons are available in the OSF repository; see <https://osf.io/tm7cx/>).

Finally, the amount of time to respond to questionnaires in ESM studies is always a critical issue. Thus we explored the option of an ultra-short, forced-choice measure of PA/NA and derived a 2 × 2-matrix. We aligned the selected emoticons in four quadrants resembling the two general activation systems of affect (see Fig. 1, left side), starting with NA high in the top left quadrant. This procedure resulted in two matrices, one of which is depicted in Fig. 10.

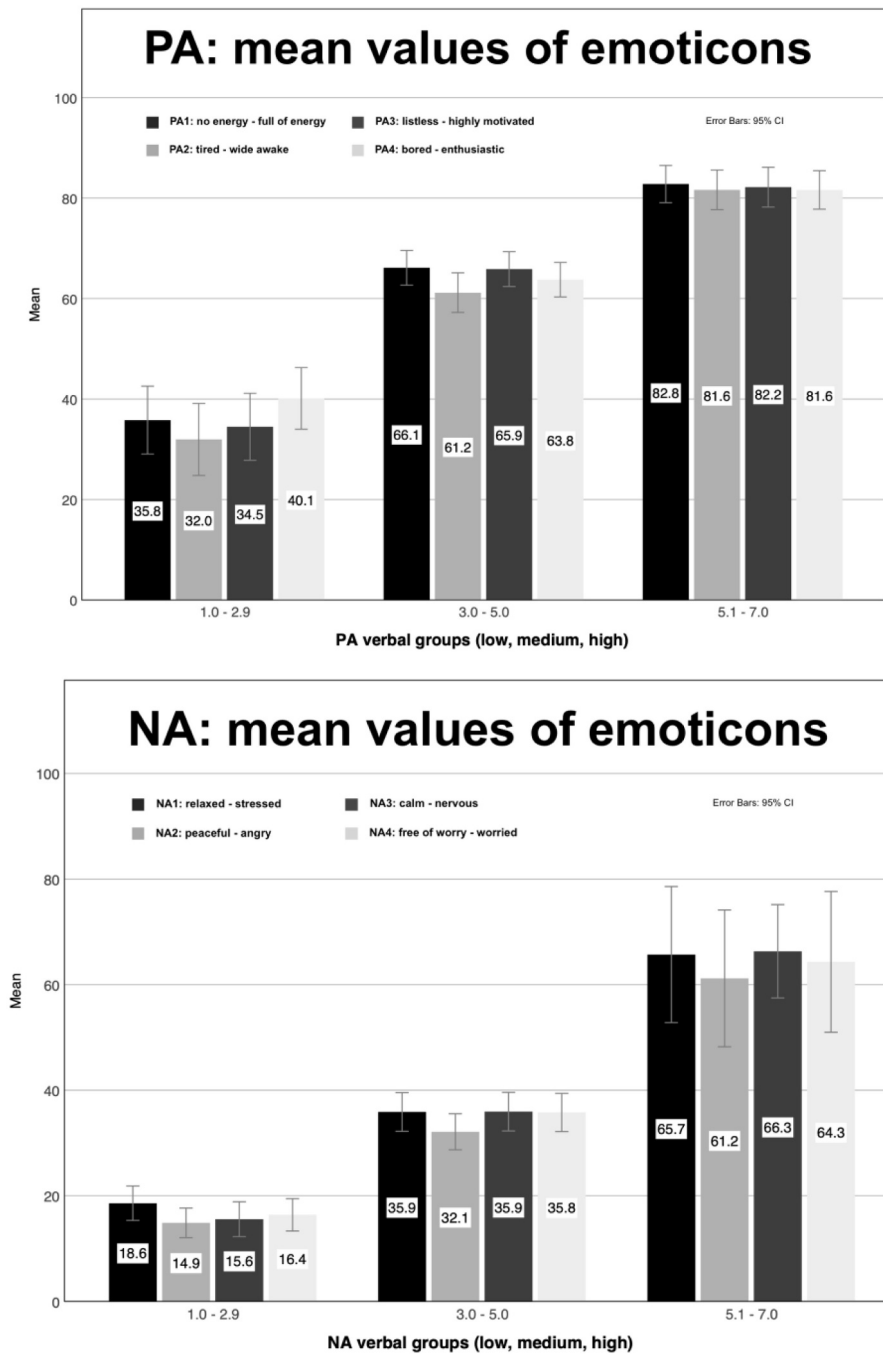

Fig. 5. Mean values of PA and NA emoticons, split for PA and NA verbal groups (PA group $n = 31/116/57$; NA group $n = 96/119/16$).

5. Study 3: Validation of LE-PANAVA

5.1. Aim

In study 3, we aimed to show that the reduced and adapted set of emoticons can be applied as a substitute of the verbal PANAVA-KS scale.

5.2. Methods

Using the same panel provider, the above selected two pairs of PA, two pairs of NA and one pair of VA emoticons were applied in an online survey, together with PANAVA-KS for examination of construct validity. In this survey, the emoticons were presented twofold, as

remarked in study 2: Once with a scale from one to seven directly beneath the pair of adjacent emoticons, presented one pair at a time (LE-PANAVA), and once with two forced choice matrices with each an emoticon for PA and NA, low and high, respectively (LE-PANA-M; see Figs. 9 and 10; see also Russell, Weiss, & Mendelsohn, 1989). The average amount of time to complete the measures was 4 minutes ($SD = 5.8$). Speeders (response time equal or below 60 s, $n = 3$) and straightliners ($n = 8$) were excluded from the sample. Multivariate outliers in the PA/NA items of the emoticons or PANAVA-KS were also excluded based on Mahalanobis Distance (cut-of criteria of 18.467/26.124 for $df = 4/8$ and $p < 0.001$; $n = 13$). Again, there were no missing values, as respondents had to choose an answer to continue with the survey. Overall, 24 cases were excluded. The final sample consisted of 294 German-speaking respondents, whereof 49.3% were

Table 3

Means (M), standard deviations (SD), internal consistencies (Cronbach's α) and correlations between the study variables of study 3 ($N = 294$).

Variables	M	SD	α	1	2	3	4	5	6	7	8
1. PA emoticon (LE-PANAVA, PA)	4.82	1.25	-	1.00							
2. NA emoticon (LE-PANAVA, NA)	2.81	1.14	-	-0.86	1.00						
3. PA PANAVA-KS	4.23	1.17	.82	0.67	-0.65	1.00					
4. NA PANAVA-KS	2.98	1.45	.79	-0.56	0.64	-0.59	1.00				
5. PA emoticon (PA3*: listless – full of energy)	4.89	1.31	-	0.95	-0.82	0.65	-0.54	1.00			
6. PA emoticon (PA4: bored – enthusiastic)	4.76	1.34	-	0.95	-0.80	0.62	-0.52	0.79	1.00		
7. NA emoticon (NA2*: relaxed – angry)	2.75	1.11	-	-0.79	0.93	-0.61	0.62	-0.77	-0.72	1.00	
8. NA emoticon (NA3: calm – nervous)	2.87	1.31	-	-0.81	0.95	-0.61	0.59	-0.76	-0.78	0.76	1.00

Note. All correlations are statistically significant ($p < .001$); * the emoticon for PA3 high (highly motivated) is replaced with PA1 high (full of energy) and NA2 low (peaceful) with NA1 low (relaxed)

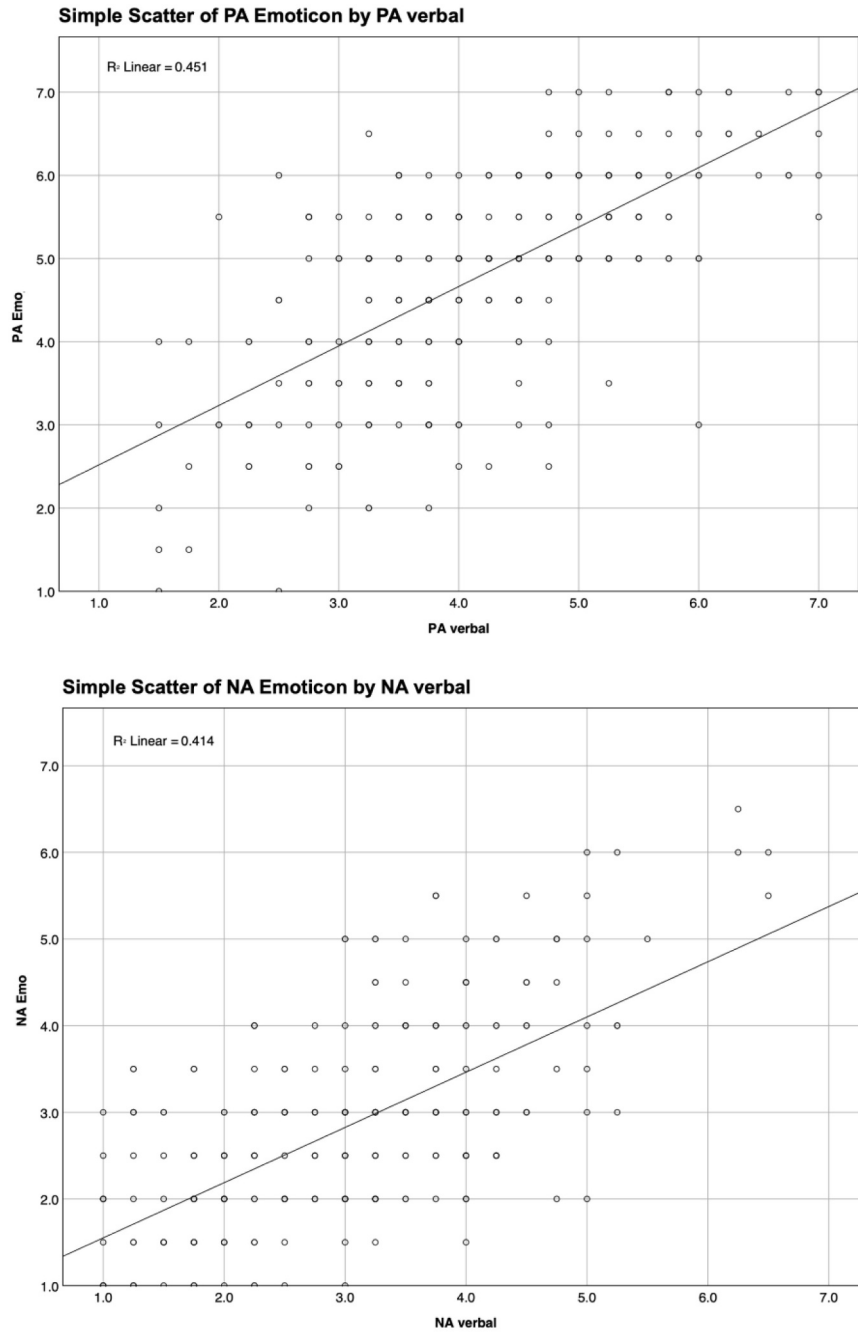

Fig. 6. Scatter plots PA/NA emoticons (LE-PANAVA) by PA/NA verbal (PANAVA-KS) ($n = 294$).

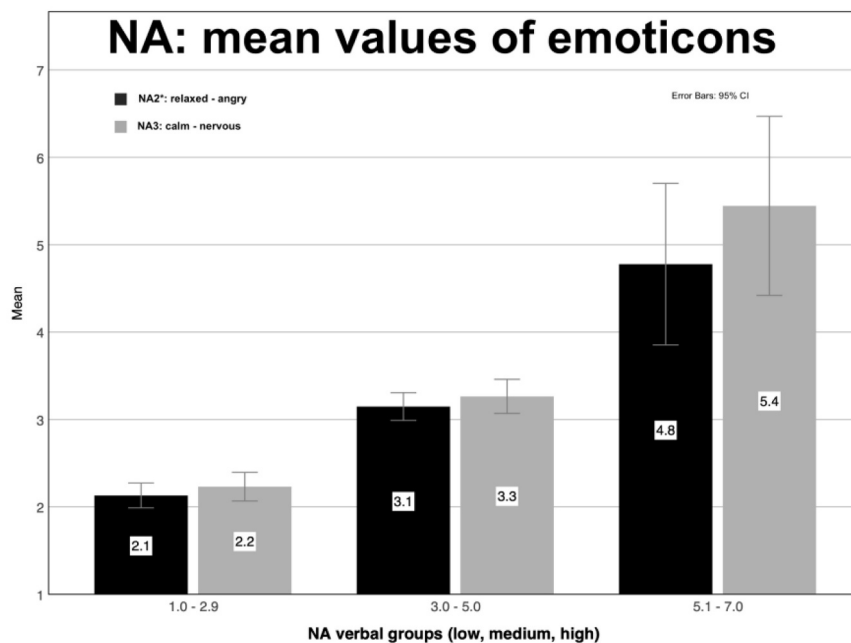
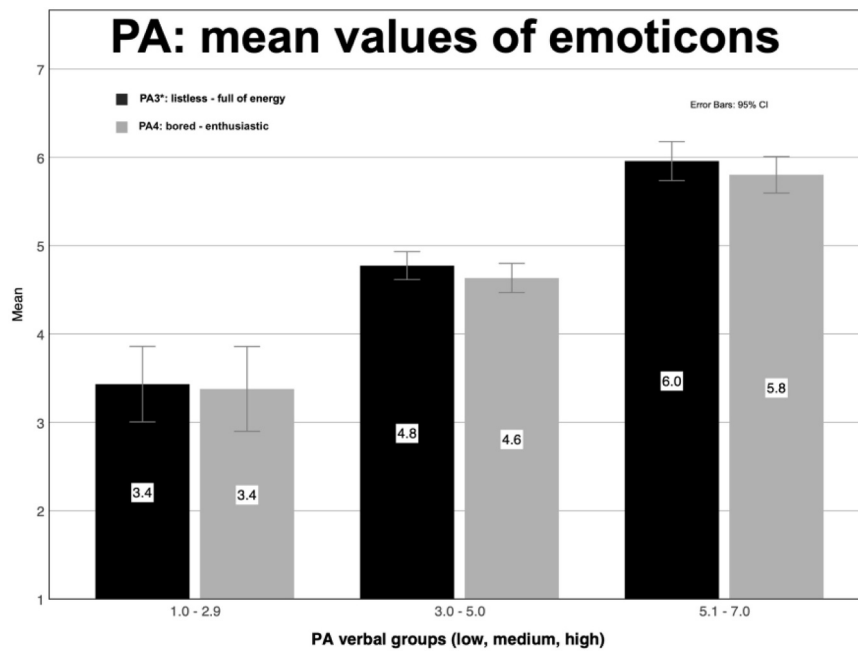

Fig. 7. Mean values of PA and NA emoticons, split for PA and NA verbal groups (PA group $n = 37/186/71$; NA group $n = 130/155/9$); * the emoticon for PA3 high (highly motivated) is replaced with PA1 high (full of energy) and NA2 low (peaceful) with NA1 low (relaxed).

female, mean age was 44.6 (SD = 16.5), and 33.3% had a higher education degree. Correlations, scatterplots, and means of the three verbalized PA and NA groups ranging from low to high activation (see above, study 2) were examined. A path model was conducted with the four emoticons as independent variables and the verbalized PA and NA scales as dependent variables, respectively. Path model analysis (conducted with the lavaan R package; Rosseel, 2012) was chosen to simultaneously examine the relationship between the four pairs of emoticons (LE-PANAVA) and PANAVA-KS. We examined residual plots to assess the assumptions of linearity, normality and homoscedasticity, which didn't reveal any conspicuous patterns (Tabachnick & Fidell, 2014). The VIF value was 3.323. Additionally, we compared the verbalized PA and NA means as well as the PA and NA emoticon means for the emoticon matrices to exploratory test LE-PANA-M.

5.3. Results

Correlations between the LE-PANAVA emoticons revealed to be lower than in study two, that is, $r = -0.86$ for PA and NA ($p < 0.001$) (see Table 3). The combined PA emoticons correlated $r = 0.67$ and $r = -0.56$ with verbalized PA and NA, respectively ($p < 0.001$). The combined NA emoticons correlated $r = -0.65$ and $r = 0.64$ with verbalized PA and NA ($p < 0.001$). Verbalized PA and NA correlated $r = -0.59$ ($p < 0.001$). Former scale exhibited a Cronbach alpha of 0.82, the latter scale of 0.79, which is comparable to the data of study 2.

The scatterplots (Fig. 6) show again that PA in our sample of online panelists was generally high and NA low, with a linear relationship between the emoticons and the verbalized scales.

As could be observed in study 2, there was a bias when responding

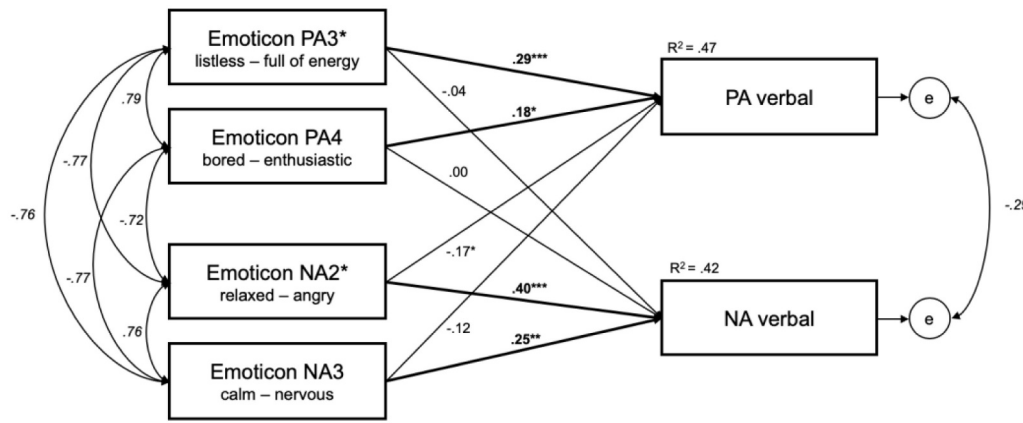

Fig. 8. Path model with PA and NA verbal as dependent variables; * $p \leq .05$, ** $p \leq .01$, *** $p \leq .001$ (marked for regression paths only); $n = 294$; * the emoticon for PA3 high (highly motivated) is replaced with PA1 high (full of energy) and NA2 low (peaceful) with NA1 low (relaxed).

Table. 4

Emoticon matrices (LE-PANA-M) with group means for PANAVA-KS verbal and LE-PANAVA ($n = 294$).

Selected Emoticon			PANAVA-KS PA verbal	PANAVA-KS NA verbal	LE-PANAVA PA emoticon scale	LE-PANAVA NA emoticon scale
Emoticon Matrix one						
PA Emoticon hi (full of energy)	%	<i>N</i>	<i>mean</i>	<i>mean</i>	<i>mean</i>	<i>mean</i>
PA Emoticon lo (listless)	11.2%	33	5.42	2.07	6.01	1.92
NA Emoticon hi (angry)	29.9%	88	3.32	3.71	3.69	3.82
NA Emoticon lo (relaxed)	1.4%	4	2.69	5.06	2.50	5.25
Total	100.0%	294	4.23	2.98	4.82	2.81
Emoticon Matrix two						
PA Emoticon hi (enthusiastic)	%	<i>N</i>	<i>mean</i>	<i>mean</i>	<i>mean</i>	<i>mean</i>
PA Emoticon lo (bored)	10.9%	32	5.35	2.34	5.92	1.92
NA Emoticon hi (nervous)	21.4%	63	3.42	3.66	3.67	3.78
NA Emoticon lo (calm)	6.1%	18	2.82	4.68	3.31	4.50
Total	100.0%	294	4.23	2.98	4.82	2.81

to the emoticons. The PA emoticons tended to get equal or slightly higher ratings as to be expected from the verbalized rating, especially for low PA. On the other hand, NA emoticons were rated lower than expected (see Fig. 7), primarily for medium to high NA, accounting for about 1 point on the rating scale. Path model analysis showed that verbalized PA was predominantly predicted by the two PA emoticons, whereby the emoticon NA2 (relaxed-angry) also revealed to have a significant influence on PA verbal (Fig. 8). Verbalized NA on the other hand was predicted solely by the NA emoticons.

Analysis of the emoticon matrices (LE-PANA-M) first showed largely comparable group means for the two matrices with PANAVA-KS and LE-PANAVA (Table 4), with deviations where group numbers were small: Only four respondents in our subsample indicated to be 'angry', whereas 18 where at least 'nervous'. Around 60% of the respondents indicated to be low in NA, that is, a pleasurable state of low negative activation. These respondents exhibited values close to the overall means of verbalized PA and NA. Another 21–30% of the respondents indicated being in an unpleasurable state of low positive activation, which is characterized by smaller PA and elevated NA on the verbalized scale. Respondents indicating high activation states – around 11% high PA and 1–6% high NA – also exhibited the highest scores on the corresponding verbalized scales (PANAVA-KS) as well as on the corresponding emoticon scales (LE-PANAVA).

6. Discussion

The development process of the emoticon-based scales for measuring the PANAVA model consisted of graphical development and selection of a set of emoticons (study 1), examination of construct validity of the set of emoticons and corresponding adjustments to the scale

(study 2), and validation of the final scales (study 3). In the conclusion section we will present our recommendation for two emoticon-based state measures of the PANAVA model. In study 2 we presented evidence for convergent and divergent validity of the emoticon-based non-verbal measures of PA and NA with PANAVA-KS (Schallberger, 2005) and the widely used PANAS (Watson et al., 1988). The scales all refer to Watson and Tellegen's (1985) two general activation systems of affect (see Fig. 1, left side). Even though the results are satisfying and the presented LE-PANAVA scale is ready for practical application (Fig. 9), some challenges need to be addressed. First, we discuss the factorial structure of the scale. The tested models revealed very satisfying fitting values. Still, the very high correlation between the LE-PANAVA PA and NA ($r = -0.86, p < 0.001$; see Table 3) suggests high interdependency of PA and NA when assessed simultaneously. Especially for practical application in everyday settings, redundancy may pose a problem for participants' commitment as well as for the time needed to complete a survey. On the other hand, convergent validity with PANAVA-KS (see Table 3) as well as criterion validity with extraversion and neuroticism (see Table 2) revealed strong convergence between emoticon-based and verbal PANAVA measures (PANAVA-KS). Additionally, path model analysis showed that verbalized PA was predominantly predicted by the two PA emoticons, whereby the emoticon NA2 (relaxed-angry) also revealed to have a significant influence on verbalized PA (see Fig. 8). Verbalized NA on the other hand was predicted solely by the NA emoticons. Thus, we conclude that the non-verbal LE-PANAVA captures the two factors PA and NA, but we are aware that PA and NA are closely interrelated, which also holds for verbal PANAVA, but to a lesser extent (see Table 3; Schallberger, 2005). We explain this slight difference between emoticon-based and verbal measures by a second challenge we want to discuss: Compared to the verbal PANAVA measure, we

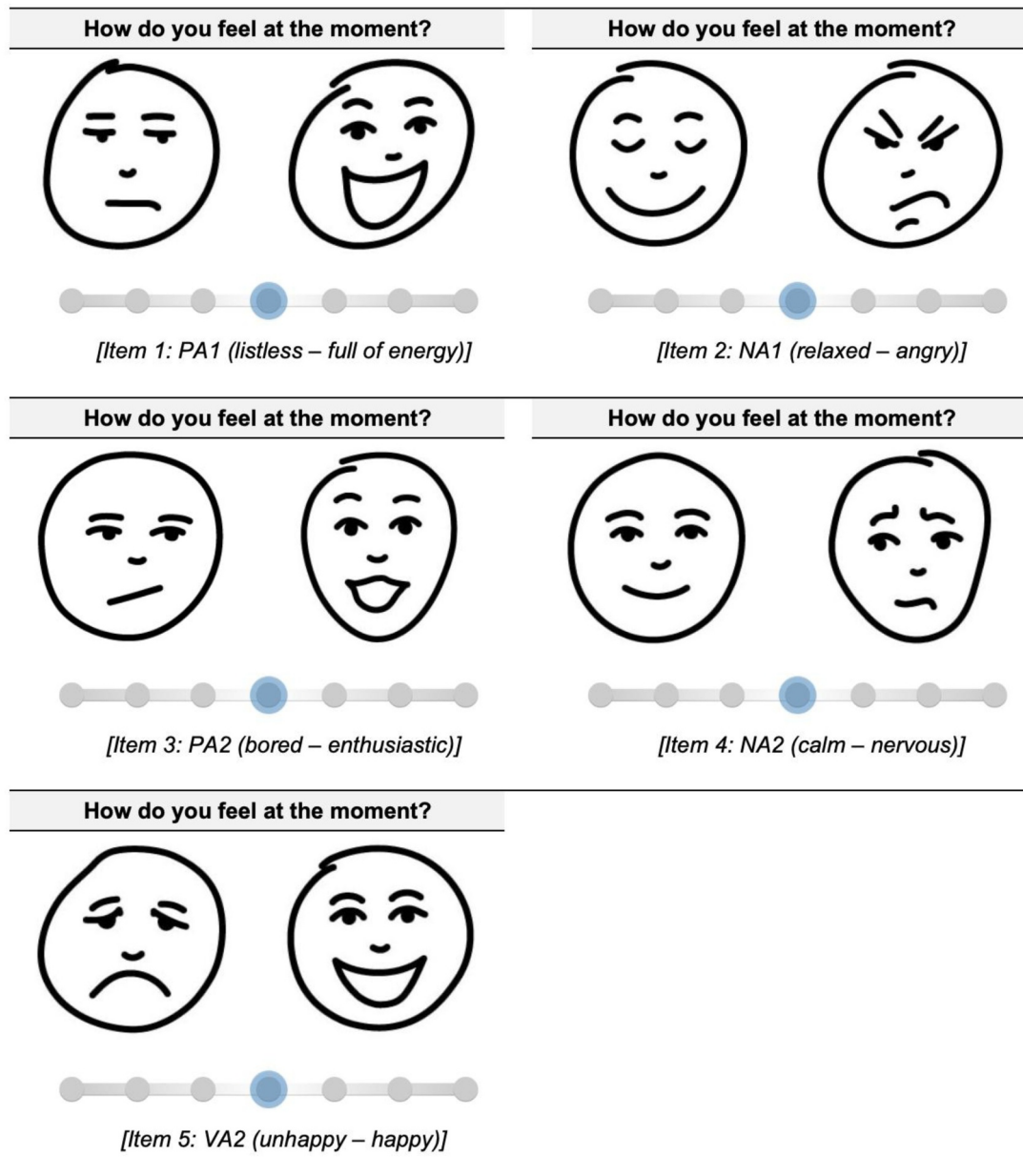

Fig. 9. Lebender Emoticon PANAVA Scale (LE-PANAVA).

identified a bias when people responded to the emoticons. The PA emoticons tended to get higher ratings as to be expected from the verbalized ratings for low and medium PA (see Fig. 7). On the other hand, NA emoticons were rated lower than expected for medium and high NA (see Fig. 7). We hypothesize that a positively activated face as depicted by the PA emoticons acts as a magnet whereas the negatively activated faces act as a repellent (especially the NA emoticon angry; see item 2 in Fig. 9). This shift to higher PA and lower NA measures leads to higher negative correlations between PA and NA. Finally, we want to point to an issue that lies within the method of data collection in the current study: Activation is usually neither high nor low when filling out online surveys. Therefore, compared to assessments of activation with ESM we may have experienced restricted variance of PA and NA for emoticon-based measures as well as for verbal measures in our sample due to limited variance of the situational characteristics. As a consequence, we strongly recommend collecting emoticon-based state measures with ESM using smartphones or -watches to get as close as possible to the everyday life of the people.

7. Limitations

As for ESM studies short and non time-consuming measures are recommended to capture momentary states of activation via mobile devices, the present study only focused on the state assessment of the PANAVA model. Schallberger (2005) concluded that depending on sample characteristics and time frame of the instruction (e.g. ‘How do you feel at the moment?’, ‘How did you feel in general?’; see Table 2) the relationships between PA, NA, and outcomes such as personality and well-being vary. He showed for example that state-oriented assessment (at the moment) leads to NA mainly influencing well-being, while for trait-oriented instructions (in general) PA overperforms NA’s influence on well-being (Schallberger, 2006). Future research should focus on factorial structure as well as dependencies of PA and NA of LE-PANAVA (and LE-PANA-M) over different time frames, especially with ESM studies, as already argued. Additionally, further research should bring more insights whether the emoticon-based assessment of the PANAVA model is an explicit measure and control for common variance

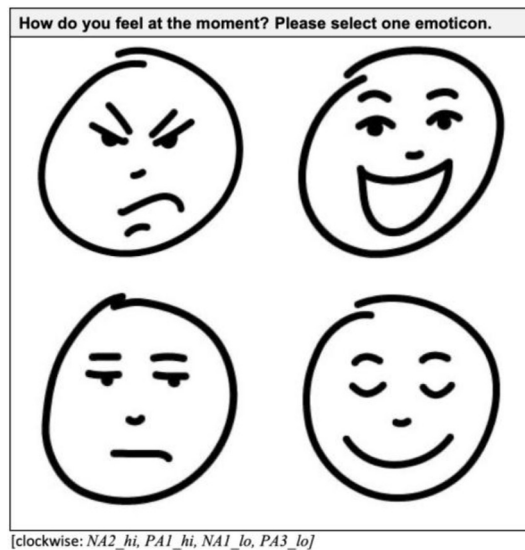

Fig. 10. Lebender Emoticon PANA Matrix (LE-PANA-M).

with implicit measures of activation such as the IPANAT (Quirin et al., 2018; Quirin, Kazén, & Kuhl, 2009). Quirin et al. (2009) have highlighted the characteristics of implicit measurements in detail. In this study we assumed an explicit measurement, which is why a detailed description of this distinction is not given. In future, we have to assume that mobile devices will not only be used for subjective self-reports, but also routinely for the objective registration of human traits, states and interactions – all technical, legal and ethical issues considered solved. As an outlook, this encompasses for example physical movement (through Global Positioning System (GPS) scans, accelerometers), social interactions (through phone/app use logs, microphone recordings), or daily activities (again through phone/app use logs, light sensors) with the so-called ‘Smartphone Sensing Methods’ (SSMs; Harari et al., 2017). Research shows that SSMs can be used for predicting personality traits (Mønsted, Mollgaard, & Mathiesen, 2018) or for examining how people feel in different locations (Sandstrom, Lathia, Mascolo, & Rentfrow, 2017). Allemand and Mehl (2017) suggest a roadmap for personality development research in everyday life, assessing daily online behavior via Linguistic Inquiry and Word Count (LIWC; Pennebaker, Boyd, Jordan, & Blackburn, 2015) and daily contexts such as situation characteristics, living contexts, or geographical contexts.

8. Conclusions

In this study we pursued the objective of presenting an instrument for assessing PA and NA using a non-verbal emoticon-based scale. We used PANAVA-KS (Schallberger, 2005) as reference and developed two forms of applications for ESM studies: The ‘Lebender Emoticon PANAVA’ scale (LE-PANAVA; see Fig. 9) and – based on the forced choice matrix version – the ‘Lebender Emoticon PANA Matrix’ (LE-PANA-M; see Fig. 10). LE-PANAVA consists of total five items (two items measuring PA, two items measuring NA, and one item measuring VA). Items should be presented one after another, as smartphone screens are of limited size. If length of questionnaire is of importance, we suggest either to use LE-PANAVA with items 1 and 2 only (listless – full of energy, relaxed – angry) or LE-PANA-M, consisting of the same four emoticons in one forced-choice item. The selection of these emoticons is based on the path model coefficients presented in Fig. 8, but as stated in study 2, other researchers may select other pairs of emoticons for their specific applications.

LE-PANAVA and LE-PANA-M are both available for future ESM research (e.g. diary studies) and practical application (e.g. blended counseling in various contexts) in the OSF repository (see <https://osf.io/tm7cx/>).

Feedback from both perspectives is more than welcome and can be directed to both authors. With regard to LE-PANA-M, further developments could implement a button in the middle for people who are undecided and do not want to choose one of the four emoticons. Future research could also allow for multiple tapping on the emoticons (once, twice, three times) for an indication of intensity. We hope that experience gained with these emoticons provide insights for the further development of the theoretical principles as well as for practical application.

Funding

The project was financially supported by the Stiftung Suzanne und Hans Biäsch zur Förderung der Angewandten Psychologie.

Author contributions

The authors were involved in all steps from conceptualization of the study to writing the manuscript.

Ethical statement

No ethical review was necessary under national, university or departmental rules. The study was conducted under strict observation of ethical and professional guidelines.

Declaration of Competing Interest

The authors declare that the research was conducted in the absence of any commercial or financial relationships that could be construed as a potential conflict of interest.

Acknowledgement

The authors would like to thank the fine arts student, Mrs Maren Lebender, who sketched and refined the emoticons for this study. This also includes Mrs Gioia Loretz and Mrs Rahel Kern, who also sketched emoticons (see Fig. 3). The authors also thank Mrs Karin Seiler, Zurich University of the Arts (ZHdK), for providing them with the opportunity to involve her students in this project.

References

- Allemand, M., & Mehl, M. R. (2017). Personality assessment in daily life: A roadmap for future personality development research. In J. Specht (Ed.), *Personality Development Across the Lifespan* (pp. 437–454). London: Academic Press. <https://doi.org/10.1016/b978-0-12-804674-6.00027-2>.
- Andersson, G. (2018). Internet interventions: Past, present and future. *Internet Interventions*, 12, 181–188. <https://doi.org/10.1016/j.invent.2018.03.008>.
- Bentler, P. M., & Chou, C.-P. (1987). Practical issues in structural modeling. *Sociological Methods & Research*, 16(1), 78–117. <https://doi.org/10.1177/0049124187016001004>.
- Betella, A., & Verschure, P. F. M. J. (2016). The affective slider: A digital self-assessment scale for the measurement of human emotions. *PLoS ONE*, 11(2), 1–11. <https://doi.org/10.1371/journal.pone.0148037>.
- Boonstra, T. W., Nicholas, J., Wong, Q. J., Shaw, F., Townsend, S., & Christensen, H. (2018). Using mobile phone sensor technology for mental health research: Integrated analysis to identify hidden challenges and potential solutions. *Journal of Medical Internet Research*, 20(7), e10131. <https://doi.org/10.2196/10131>.
- Bradley, M., & Lang, P. J. (1994). Measuring emotion: The self-Assessment Manikin and the semantic differential. *Journal of Behavior Therapy and Experimental Psychiatry*, 25(1), 49–59. [https://doi.org/10.1016/0005-7916\(94\)90063-9](https://doi.org/10.1016/0005-7916(94)90063-9).
- Brose, A., Schmiedek, F., Gerstorf, D., & Voelke, M. C. (2019). The measurement of within-person affect variation. *Emotion*. <https://doi.org/10.1037/emo0000583>.
- Budner, P., Eirich, J., & Gloor, P. A. (2017). “Making you happy makes me happy” Measuring individual mood with smartwatches. Retrieved from <http://arxiv.org/abs/1711.06134>.
- Bulmer, M. (1979). *Principles of statistics*. New York: Dover.
- Busseri, M. A. (2018). Examining the structure of subjective well-being through meta-analysis of the associations among positive affect, negative affect, and life satisfaction. *Personality and Individual Differences*, 122, 68–71. <https://doi.org/10.1016/j.paid.2017.10.003>.
- Conner, T. S., Tennen, H., Fleeson, W., & Barrett, L. F. (2009). Experience sampling

- methods: A modern idiographic approach to personality research. *Social and Personality Psychology Compass*, 3, 292–313. <https://doi.org/10.1111/j.1751-9004.2009.00170.x>.
- R: A Language and Environment for Statistical Computing. Vienna, Austria.: Core Development Team, R. Retrieved from <https://www.R-project.org/>.
- Crawford, J. R., & Henry, J. D. (2004). The positive and negative affect schedule (PANAS): Construct validity, measurement properties and normative data in a large non-clinical sample. *The British Journal of Clinical Psychology*, 43, 245–265. <https://doi.org/10.1348/0144665031752934>.
- Csikszentmihalyi, M., & Larson, R. (2014). Validity and Reliability of the Experience-Sampling Method. In M. Csikszentmihalyi (Ed.), *Flow and the Foundations of Positive Psychology: The Collected Works of Mihaly Csikszentmihalyi* (pp. 35–54). Dordrecht: Springer. https://doi.org/10.1007/978-94-017-9088-8_3.
- Diener, E., Suh, E. M., Lucas, R. E., & Smith, H. L. (1999). Subjective well-being: Three decades of progress. *Psychological Bulletin*, 125(2), 276–302. <https://doi.org/10.1006/pupt.1998.0157>.
- Diener, E., Wirtz, D., Biswas-Diener, R., Tov, W., Kim-Prieto, C., Choi, D., et al. (2009). New measures of well-being. In E. Diener (Vol. Ed.), *Assessing well-being: the collected works of Ed diener, social indicators research series: vol. 39*, (pp. 247–266). Dordrecht: Springer. <https://doi.org/10.1007/978-90-481-2354-4>.
- Diener, E., Wirtz, D., Tov, W., Kim-Prieto, C., Choi, D., Oishi, S., et al. (2010). New well-being measures: Short scales to assess flourishing and positive and negative feelings. *Social Indicators Research*, 97, 143–156. <https://doi.org/10.1007/s11205-009-9493-y>.
- Ebner-Priemer, U. W., & Trull, T. J. (2009). Ambulatory assessment: An innovative and promising approach for clinical psychology. *European Psychologist*, 14(2), 109–119. <https://doi.org/10.1027/1016-9040.14.2.109>.
- Gaudreau, P., Sanchez, X., & Blondin, J. P. (2006). Positive and negative affective states in a performance-related setting testing the factorial structure of the PANAS across two samples of French-Canadian participants. *European Journal of Psychological Assessment*, 22(4), 240–249. <https://doi.org/10.1027/1015-5759.22.4.240>.
- Gloor, P. A., Colladon, Fronzetti, A., Grippa, F., Budner, P., & Eirich, J. (2018). Aristotle said “Happiness is a state of activity” — Predicting mood through body sensing with smartwatches. *Journal of Systems Science and Systems Engineering*, 27(5), 586–612. <https://doi.org/10.1007/s11518-018-5383-7>.
- Gray, J. A. (1982). *The neuropsychology of anxiety: An enquiry into the functions of the septo-hippocampal system. The neuropsychology of anxiety: An enquiry into the functions of the septo-hippocampal system*. New York, NY: Clarendon Press/Oxford University Press US.
- Harari, G. M., Müller, S. R., Aung, M. S., & Rentfrow, P. J. (2017). Smartphone sensing methods for studying behavior in everyday life. *Current Opinion in Behavioral Sciences*, 18, 83–90. <https://doi.org/10.1016/j.cobeha.2017.07.018>.
- Hengartner, M. P., Graf, M., & Schreiber, M. (2017). Traits across the personality hierarchy differentially relate to positive and negative affect: Evidence for the predictive validity of empirically derived meta-traits. *Personality and Mental Health*, 11, 132–143. <https://doi.org/10.1002/pmh>.
- Heubeck, B. G., & Wilkinson, R. (2019). Is all fit that glitters gold? Comparisons of two, two and bi-factor models for Watson, Clark & Tellegen’s 20-item state and trait PANAS. *Personality and Individual Differences*, 144, 132–140. <https://doi.org/10.1016/j.paid.2019.03.002>.
- Howell, R. T., Ksendzova, M., Nestingen, E., Yerhian, C., & Iyer, R. (2017). Your personality on a good day: How trait and state personality predict daily well-being. *Journal of Research in Personality*, 69, 250–263. <https://doi.org/10.1016/j.jrp.2016.08.001>.
- Hu, L.-T., & Bentler, P. M. (1999). Cutoff criteria for fit indexes in covariance structure analysis: Conventional criteria versus new alternatives. *Structural Equation Modeling: A Multidisciplinary Journal*, 6(1), 1–55. <https://doi.org/10.1080/10705519909540118>.
- Jacobi, C. (2019). Special issue internet interventions: Editorial integrating technology into mental health care delivery in Europe (ICare). *Internet Interventions*, 16, 1–4. <https://doi.org/10.1016/j.invent.2018.07.001>.
- Jayawickreme, E., Forgeard, M. J. C., & Seligman, M. E. P. (2012). The engine of well-being. *Review of General Psychology*, 16(4), 327–342. <https://doi.org/10.1037/a0027990>.
- Jones, A. B., Brown, N. A., Serfuss, D. G., & Sherman, R. A. (2017). Personality and density distributions of behavior, emotions, and situations. *Journal of Research in Personality*, 69, 225–236. <https://doi.org/10.1016/j.jrp.2016.10.006>.
- Komulainen, E., Meskanen, K., Lipsanen, J., Lahti, J. M., Jylhä, P., Melartin, T., et al. (2014). The effect of personality on daily life emotional processes. *PLoS ONE*, 9(10), e110907. <https://doi.org/10.1371/journal.pone.0110907>.
- Krohne, H. W., Eglhoff, B., Kohlmann, C. W., & Tausch, A. (1996). Untersuchungen mit einer Deutschen version der “Positive and Negative Affect Schedule” (PANAS). *Diagnostica*, 42(2), 139–156.
- Kuhl, J. (2018). Individual differences in self-regulation. In J. Heckhausen, & H. Heckhausen (Eds.), *Motivation and action* (pp. 529–577). (3rd ed). Cham: Springer.
- Larson, R., & Csikszentmihalyi, M. (2014). The Experience Sampling Method. In M. Csikszentmihalyi (Ed.), *Flow and the Foundations of Positive Psychology: The Collected Works of Mihaly Csikszentmihalyi* (pp. 21–34). Dordrecht: Springer. https://doi.org/10.1007/978-94-017-9088-8_2.
- Lehmann, A. I., Brauchli, R., Jenny, G. J., Füllemann, D., & Bauer, G. F. (2018). Baseline psychosocial and affective context characteristics predict outcome expectancy as a process appraisal of an organizational health intervention. *International Journal of Stress Management*, 27(1), 1–11. <https://doi.org/10.1037/str0000119>.
- Lehr, D., Geraedts, A., Persson Asplund, R., Khadjesari, Z., Heber, E., de Bloom, J., et al. (2016). Occupational e-mental health: Current approaches and promising perspectives for promoting mental health in workers. *Healthy at Work*, 257–281. https://doi.org/10.1007/978-3-319-32331-2_19.
- Little, B. R., & Coulombe, S. (2015). Personal Projects. In J. D. Wright (Ed.), *International encyclopedia of the social and behavioral sciences* (pp. 757–765). New York: Elsevier. <https://doi.org/10.1016/B978-0-08-097086-8.26100-X> 2nd ed.
- Mønsted, B., Mollgaard, A., & Mathiesen, J. (2018). Phone-based metric as a predictor for basic personality traits. *Journal of Research in Personality*, 74, 16–22. <https://doi.org/10.1016/j.jrp.2017.12.004>.
- Münsterberg, H. (1916). *Das Lichtspiel: Eine psychologische Studie (1916) und andere Schriften zum Kino*. Wien: SYNEMA.
- Pennebaker, J. W., Boyd, R. L., Jordan, K., & Blackburn, K. (2015). *The development and psychometric properties of LIWC2015*. Austin, TX: University of Texas at Austin.
- Pollak, J., Adams, P., & Gay, G. (2011). PAM: A photographic affect meter for frequent, in situ measurement of affect. *Proceedings of the International Conference on Human Factors in Computing Systems*, 725–734. <https://doi.org/10.1145/1978942.1979047>.
- Posner, J., Russell, J. A., & Peterson, B. S. (2005). The circumplex model of affect: An integrative approach to affective neuroscience, cognitive development, and psychopathology. *Development and Psychopathology*, 17(3), 715–734. <https://doi.org/10.1016/j.surg.2006.10.010>. Use.
- Quirin, M., Kazén, M., & Kuhl, J. (2009). When nonsense sounds happy or helpless: The Implicit Positive and Negative Affect Test (IPANAT). *Journal of Personality and Social Psychology*, 97(3), 500–516. <https://doi.org/10.1037/a0016063>.
- Quirin, M., Wróbel, M., Pala, A. N., Stieger, S., Brosschot, J., Kazén, M., et al. (2018). A cross-cultural validation of the implicit positive and negative affect test (IPANAT): Results from ten countries across three continents. *European Journal of Psychological Assessment*, 34(1), 52–63. <https://doi.org/10.1027/1015-5759/a000315>.
- Rosseev, Y. (2012). lavaan: An R Package for Structural Equation Modeling. *Journal of Statistical Software*, 48(2), 1–36 Retrieved from: <http://www.jstatsoft.org/v48/i02/>.
- Runyan, J. D., Steenbergh, T. A., Bainbridge, C., Daugherty, D. A., Oke, L., & Fry, B. N. (2013). A smartphone ecological momentary assessment/intervention “app” for collecting real-time data and promoting self-awareness. *PLoS ONE*, 8(8), <https://doi.org/10.1371/journal.pone.0071325>.
- Russell, J. A. (1980). A circumplex model of affect. *Journal of Personality and Social Psychology*, 39, 1161–1178. <https://doi.org/10.1037/h0077714>.
- Russell, J. A., & Carroll, J. M. (1999). On the bipolarity of positive and negative affect. *Psychological Bulletin*, 125(1), 3–30. <https://doi.org/10.1037/0033-2909.125.1.3>.
- Russell, J. A., Weiss, A., & Mendelsohn, G. A. (1989). Affect Grid: A Single-Item Scale of Pleasure and Arousal. *Journal of Personality and Social Psychology*, 57(3), 493–502. <https://doi.org/10.1037/0022-3514.57.3.493>.
- Sandstrom, G. M., Lathia, N., Mascolo, C., & Rentfrow, P. J. (2017). Putting mood in context: Using smartphones to examine how people feel in different locations. *Journal of Research in Personality*, 69, 96–101. <https://doi.org/10.1016/j.jrp.2016.06.004>.
- Satorra, A., & Bentler, P. M. (1994). Corrections to test statistics and standard errors in covariance structure analysis. In A. V. Eye, & C. C. Clogg (Eds.), *Latent variables analysis: applications for developmental research* (pp. 399–419). Thousand Oaks, CA: Sage.
- Schallberger, U. (2005). *Kurzskalen zur Erfassung der Positiven Aktivierung, Negativen Aktivierung und Valenz in Experience Sampling Studien (PANAVA-KS)*. Forschungsberichte aus dem Projekt: Qualität des Erlebens in Arbeit und Freizeit. Zürich: Universität Zürich Retrieved from: http://www.psychologie.uzh.ch/institut/angehoerige/emeriti/schallberger/schallberger-pub/PANAVA_05.pdf.
- Schallberger, U. (2006). Die zwei Gesichter der Arbeit und ihre Rolle für das Wohlbefinden: Eine aktivierungstheoretische Interpretation. *Wirtschaftspsychologie*, 96–102 2/3.
- Schallberger, U., & Pfister, R. (2001). Flow-Erleben in Arbeit und Freizeit. *Zeitschrift Für Arbeits- und Organisationspsychologie*, 45(4), 176–187. <https://doi.org/10.1026/0932-4089.45.4.176>.
- Schallberger, U., & Venetz, M. (1999). (2009). Kurzversionen der MRS-Inventars von Ostendorf (1990) zur Erfassung der fünf “grossen” Persönlichkeitsfaktoren. *Berichte aus der Abteilung Psychologie (No. 30)*. Zürich: Universität Zürich Retrieved from <http://www.psychologie.uzh.ch/institut/angehoerige/emeriti/schallberger/schallberger-pub/BAAAPMRS30.pdf>.
- Seib-Pfeifer, L. E., Pugnaghi, G., Beauducel, A., & Leue, A. (2017). On the replication of factor structures of the Positive and Negative Affect Schedule (PANAS). *Personality and Individual Differences*, 107, 201–207. <https://doi.org/10.1016/j.paid.2016.11.053>.
- Shevlin, M., & Miles, J. N. V. (1998). Effects of sample size, model specification and factor loadings on the GFI in confirmatory factor analysis. *Personality and Individual Differences*, 25, 85–90. [https://doi.org/10.1016/S0191-8869\(98\)00055-5](https://doi.org/10.1016/S0191-8869(98)00055-5).
- Tabachnick, B. G., & Fidell, L. S. (2014). *Using multivariate statistics*. Essex: Pearson Education 6th Ed.
- Thayer, R. E. (1989). *The biopsychology of mood and arousal*. New York, NY: US: Oxford University Press.
- Thompson, E. R. (2007). Development and validation of an internationally reliable short-form of the positive and negative affect schedule (PANAS). *Journal of Cross-Cultural Psychology*, 38(2), 227–242. <https://doi.org/10.1177/0022022106297301>.
- Tourangeau, R., Couper, M. P., & Conrad, F. (2007). Color, labels, and interpretive heuristics for response scales. *The Public Opinion Quarterly*, 71(1), 91–112. <https://doi.org/10.1093/poq/nfl046>.
- Van Vaerenbergh, Y., & Thomas, T. D. (2013). Response styles in survey research: A literature review of antecedents, consequences, and remedies. *International Journal of Public Opinion Research*, 25(2), 195–217. <https://doi.org/10.1093/ijpor/eds021>.
- Walter, S. L., Seibert, S. E., Goering, D., & O’Boyle, E. H. (2018). A Tale of Two Sample Sources: Do Results from Online Panel Data and Conventional Data Converge. *Journal of Business and Psychology*, 425–452. <https://doi.org/10.1007/s10869-018-9552-y>.
- Watson, D., Clark, L. A., & Tellegen, A. (1988). Development and validation of brief measures of positive and negative affect: The PANAS scales. *Journal of Personality and Social Psychology*, 54(6), 1063–1070. <https://doi.org/10.1037/0022-3514.54.6.1063>.

- Watson, D., & Tellegen, A. (1985). Toward a consensual structure of mood. *Psychological Bulletin*, 98(2), 219–235. <https://doi.org/10.1037/0033-2909.98.2.219>.
- Watson, D., Wiese, D., Vaidya, J., & Tellegen, A. (1999). The two general activation systems of affect: Structural findings, evolutionary considerations, and psychobiological evidence. *Journal of Personality and Social Psychology*, 76(5), 820–838.
- Wilt, J., Nofle, E. E., Fleeson, W., & Spain, J. S. (2012). The dynamic role of personality states in mediating the relationship between extraversion and positive affect. *Journal of Personality*, 80(October 2012), 1205–1236. <https://doi.org/10.1111/j.1467-6494.2011.00756.x>.
- Wilt, J., & Revelle, W. (2019). The Big Five, everyday contexts and activities, and affective experience. *Personality and Individual Differences*, 136(March 2017), 140–147. <https://doi.org/10.1016/j.paid.2017.12.032>.
- Wright, A. G. C., & Zimmermann, J. (2019). Applied Ambulatory Assessment: Integrating Idiographic and Nomothetic Principles of Measurement. *Psychological Assessment*. <https://doi.org/10.1037/pas0000685>.
- Zurbriggen, C. L. A., Venetz, M., & Hinni, C. (2018). The quality of experience of students with and without special educational needs in everyday life and when relating to peers. *European Journal of Special Needs Education*, 33(2), 205–220. <https://doi.org/10.1080/08856257.2018.1424777>.